

25 FB
Stainless

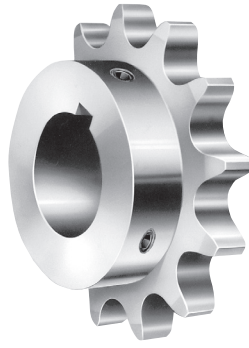

1/4" PITCH - SINGLE STRAND - **STAINLESS STEEL**

A.N.S.I. No. 25 - Type B Sprockets - Hub One Side

Finished Bore

Complete With Any Bore Size Indicated - Standard Straight Keyway and **TWO SETSCREWS**

Size and List Price		BORE SIZES AVAILABLE WITH KEYWAY AND TWO SETSCREWS					Dimensions - Weights	
Catalog No.	List Price	1/4*	3/8*	1/2	5/8	3/4	Pitch Diameter	Approx. Weight
25FB10SS	39.80	X					.809	.03
25FB11SS	43.00	X	X				.887	.04
25FB12SS	43.40	X	X				.966	.06
25FB13SS	43.80	X	X	X			1.045	.07
25FB14SS	46.00	X		X			1.124	.08
25FB15SS	46.40			X			1.203	.1
25FB16SS	56.20			X			1.282	.1
25FB17SS	59.20			X			1.361	.1
25FB18SS	59.80			X	X		1.440	.2
25FB19SS	60.60			X	X		1.519	.2
25FB20SS	62.80			X	X		1.598	.2
25FB21SS	65.60			X			1.678	.3
25FB24SS	74.00			X	X		1.915	.3
25FB25SS	76.80			X	X	X	1.995	.3
25FB28SS	88.40			X		X	2.233	.4
25FB30SS	95.90			X	X		2.392	.4

* 1/4" and 3/8" Bore sizes have two set screws only - No keyway

Also available from stock...



Change Gears

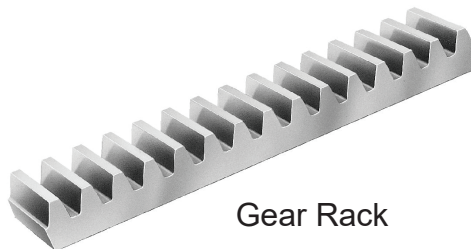

Gear Rack

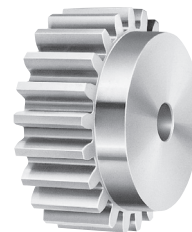

Spur Gears

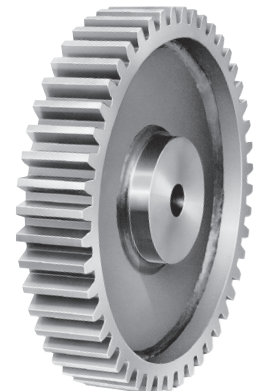



35 FB
Stainless



3/8" PITCH - SINGLE STRAND - STAINLESS STEEL

A.N.S.I. No. 35 - Type B Sprockets - Hub One Side

Finished Bore

Complete With Any Bore Size Indicated - Standard Straight Keyway and TWO SETSCREWS

Size and List Price		BORE SIZES AVAILABLE WITH KEYWAY AND TWO SETSCREWS						Dimensions - Weights	
Catalog No.	List Price	*3/8	1/2	5/8	3/4	7/8	1	Pitch Diameter	Approx. Weight
35FB 9SS	44.60	X						1.096	.1
35FB10SS	46.80	X	X					1.214	.2
35FB11SS	50.00	X	X	X				1.331	.2
35FB12SS	50.60		X	X	X			1.449	.2
35FB13SS	54.00		X	X	X			1.567	.3
35FB14SS	54.60		X	X	X			1.685	.3
35FB15SS	59.20		X	X	X	X		1.804	.3
35FB16SS	70.20			X	X	X		1.922	.4
35FB17SS	73.00			X	X		X	2.041	.4
35FB18SS	74.20			X	X	X	X	2.159	.5
35FB20SS	82.00			X	X	X	X	2.278	.6
35FB21SS	88.20			X	X	X	X	2.516	.8
35FB22SS	94.40			X	X		X	2.635	.9
35FB23SS	101.00				X		X	2.754	1.1
35FB24SS	107.00			X	X		X	2.873	1.2
35FB25SS	113.00				X		X	2.992	1.2
35FB26SS	119.00			X	X		X	3.111	1.3
35FB28SS	131.00				X		X	3.349	1.3
35FB30SS	143.00				X		X	3.588	1.4

*3/8" Bore sizes have two set screws only - No keyway.

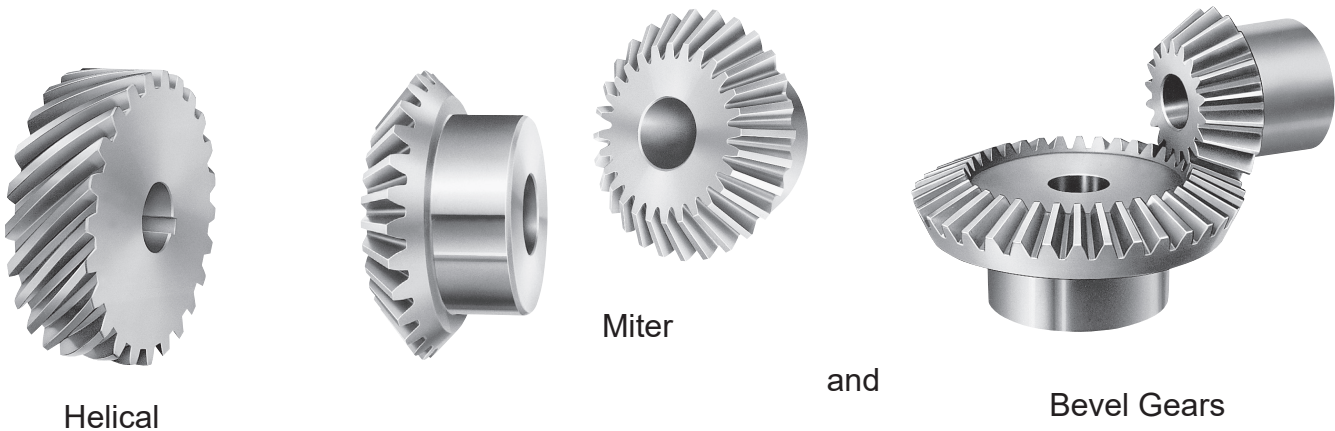

LINN GEAR COMPANY

**40 FB
Stainless**

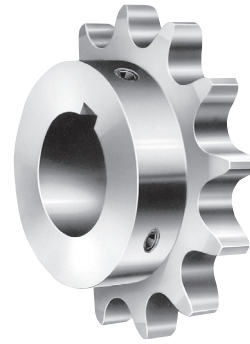
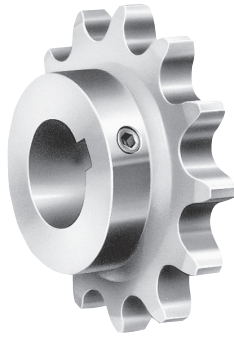

1/2" PITCH (.312 ROLL) - SINGLE STRAND - STAINLESS STEEL

A.N.S.I. No. 40 - Type B Sprockets - Hub One Side

Finished Bore

Complete With Any Bore Size Indicated - Standard Straight Keyway and TWO SETSCREWS

Size and List Price		BORE SIZES AVAILABLE WITH KEYWAY AND TWO SETSCREWS								Dimensions - Weights	
Catalog No.	List Price	1/2	5/8	3/4	7/8	1	1 1/8	1 3/16	1 1/4	Pitch Diameter	Approx. Weight
40FB 9SS	55.30	X	X							1.462	.1
40FB10SS	58.90	X	X	X						1.618	.2
40FB11SS	64.90	X	X	X						1.775	.2
40FB12SS	65.70	X	X	X	X	X				1.932	.3
40FB13SS	71.30	X	X	X	X	X				2.089	.4
40FB14SS	82.90		X	X	X	X				2.247	.5
40FB15SS	86.40		X	X	X	X	X	X	X	2.405	.6
40FB16SS	90.90		X	X	X	X	X	X	X	2.563	.7
40FB17SS	93.60		X	X	X	X	X	X	X	2.721	.8
40FB18SS	100.00			X	X	X	X		X	2.879	.9
40FB19SS	110.00			X	X	X	X		X	3.038	1.1
40FB20SS	122.00			X	X	X	X	X	X	3.196	1.3
40FB21SS	132.00			X	X	X	X		X	3.355	1.6
40FB22SS	143.00			X	X	X	X	X	X	3.513	1.6
40FB23SS	153.00			X	X	X	X		X	3.672	1.8
40FB24SS	164.00			X		X	X		X	3.831	1.8
40FB25SS	172.00			X	X	X	X		X	3.989	1.9
40FB26SS	183.00			X	X	X	X		X	4.148	2.0
40FB28SS	205.00			X		X	X	X	X	4.466	2.1
40FB30SS	227.00			X		X	X	X	X	4.783	2.3

COMPLETE GEARBOX REPAIR & REBUILD
SERVICE AVAILABLE



50 FB
Stainless

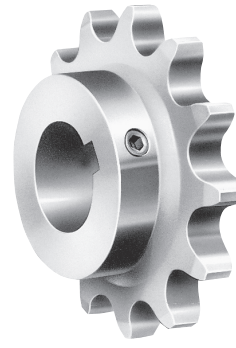
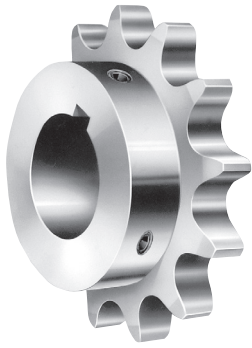

5/8" PITCH - SINGLE STRAND - **STAINLESS STEEL**

A.N.S.I. No. 50 - Type B Sprockets - Hub One Side

Finished Bore

Complete With Any Bore Size Indicated - Standard Straight Keyway and **TWO SETSCREWS**

Size and List Price		BORE SIZES AVAILABLE WITH KEYWAY AND TWO SETSCREWS								Dimensions - Weights	
Catalog No.	List Price	5/8	3/4	7/8	1	1 1/8	1 3/16	1 1/4	1 3/8	Pitch Diameter	Approx. Weight
50FB 9SS	69.90		X							1.827	.2
50FB10SS	77.30		X	X	X					2.023	.4
50FB11SS	88.90	X	X	X	X					2.219	.5
50FB12SS	89.90	X	X	X	X	X				2.415	.6
50FB13SS	100.00		X		X	X	X	X		2.612	.7
50FB14SS	109.00		X	X	X	X		X		2.809	.9
50FB15SS	114.00		X	X	X	X	X	X	X	3.006	1.1
50FB16SS	123.00		X	X	X	X	X	X	X	3.204	1.3
50FB17SS	128.00		X	X	X	X	X	X	X	3.401	1.6
50FB18SS	138.00		X		X	X	X	X	X	3.599	1.8
50FB19SS	147.00				X	X		X	X	3.797	2.0
50FB20SS	166.00				X	X	X	X	X	3.995	2.1
50FB21SS	188.00				X	X	X	X	X	4.193	2.2
50FB22SS	212.00				X	X		X	X	4.392	2.4
50FB23SS	235.00							X	X	4.590	2.5
50FB24SS	260.00				X	X	X	X		4.788	2.7
50FB25SS	281.00				X	X		X	X	4.987	2.8
50FB26SS	297.00				X	X		X	X	5.185	2.9
50FB28SS	312.00				X		X	X		5.582	3.2

METRIC STAINLESS STEEL

Sprockets & Gears Available Made-To-Order

LINN GEAR COMPANY

**60 FB
Stainless**

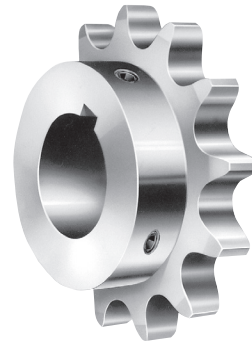
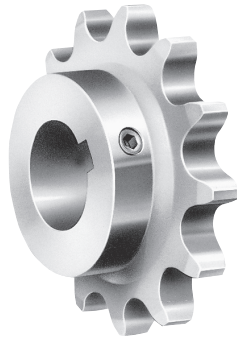

3/4" PITCH - SINGLE STRAND - STAINLESS STEEL

A.N.S.I. No. 60 - Type B Sprockets - Hub One Side

Finished Bore

Complete With Any Bore Size Indicated - Standard Straight Keyway and TWO SETSCREWS

Size and List Price		BORE SIZES AVAILABLE WITH KEYWAY AND TWO SETSCREWS									Dimensions - Weights	
Catalog No.	List Price	3/4	7/8	1	1 1/8	1 3/16	1 1/4	1 3/8	1 7/16	1 1/2	Pitch Diameter	Approx. Weight
60FB 9SS	89.20	X		X							2.193	.5
60FB10SS	97.00	X	X	X	X	X	X				2.427	.6
60FB11SS	108.00		X	X	X		X				2.662	.8
60FB12SS	114.00	X	X	X	X		X	X	X		2.898	1.2
60FB13SS	133.00		X	X	X		X		X	X	3.134	1.7
60FB14SS	142.00		X	X			X	X	X	X	3.371	1.8
60FB15SS	166.00		X	X	X	X	X	X	X	X	3.607	2.2
60FB16SS	179.00			X	X	X	X		X	X	3.844	2.4
60FB17SS	195.00			X	X		X	X	X	X	4.082	2.6
60FB18SS	210.00			X	X		X		X	X	4.319	2.7
60FB19SS	226.00			X			X		X		4.557	2.9
60FB20SS	244.00				X	X	X	X	X	X	4.794	3.1
60FB21SS	266.00				X	X	X		X	X	5.032	3.4
60FB22SS	285.00				X	X	X	X	X	X	5.270	3.7
60FB23SS	305.00						X	X	X	X	5.508	4.7
60FB24SS	336.00					X	X		X	X	5.746	4.9
60FB25SS	362.00					X	X		X	X	5.984	5.2
60FB26SS	375.00						X		X	X	6.222	5.5

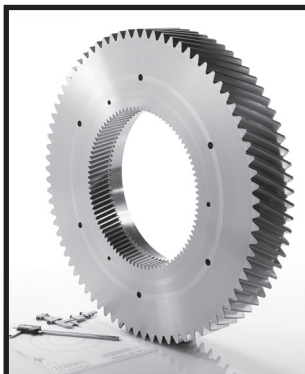

**Ask us about
PRECISION GEARING**

See last page for details.





1/2" PITCH (.312 ROLL) - SINGLE STRAND - **STAINLESS STEEL**

A.N.S.I. No. 40 - Type A Sprockets - No Hub - Mandrel Bore

Size and List Price		Alteration Charges - List Price Each		Dimensions - Weights		
Catalog No.	List Price	Quantity Identical Items	Re-Bore Each	Pitch Diameter	Stock Bore	Approx. Wt.
40A13SS	47.10			2.089	.500	.3
40A14SS	51.20			2.247	.500	.4
40A15SS	51.70			2.405	.500	.4
40A16SS	55.80			2.563	.500	.4
40A17SS	56.30			2.721	.625	.5
40A18SS	61.20			2.879	.625	.5
40A19SS	65.80			3.038	.625	.6
40A20SS	72.10			3.196	.625	.6
40A21SS	72.70			3.355	.625	.7
40A22SS	78.90	1	30.00	3.513	.625	.7
40A23SS	79.40	2 - 4	21.00	3.672	.625	.9
40A24SS	85.80	5 - 9	18.00	3.831	.625	.9
		10 - 24	16.50			
40A25SS	92.10			3.989	.625	1.0
40A26SS	92.60			4.148	.625	1.1
40A28SS	93.20			4.466	.625	1.2
40A30SS	95.90			4.783	.625	1.4
40A32SS	108.00			5.101	.625	1.6
40A35SS	121.00			5.578	.625	2.0
40A36SS	125.00			5.737	.625	2.1
40A40SS	142.00			6.373	.750	2.5
40A45SS	165.00			7.168	.750	3.2
40A48SS	181.00			7.645	.750	3.7
40A54SS	213.00	1	40.00			
		2 - 4	28.00	8.599	.750	4.6
40A60SS	245.00	5 - 9	24.00	9.555	.750	5.8
		10 - 24	22.00			

DRILLING, COUNTERSINKING, SPOTFACING or TAPPING bolt holes - Add preparation charge of \$20.00 divided by the number of identical items plus \$2.50 per hole to list price for each operation required. (Use only one preparation charge when more than one operation is performed on the same part.)

SPLITTING - Add preparation charge of \$10.00 divided by the number of identical items plus \$.20 per tooth to the list price. This does not include reinforcing the rim or any other arrangement for holding the sprocket in pitch.

**50 A
Stainless**



5/8" PITCH - SINGLE STRAND - STAINLESS STEEL

A.N.S.I. No. 50 - Type A Sprockets - No Hub - Mandrel Bore

Size and List Price		Alteration Charges - List Price Each		Dimensions - Weights		
Catalog No.	List Price	Quantity Identical Items	Re-Bore Each	Pitch Diameter	Stock Bore	Approx. Weight
50A13SS	56.90			2.612	.625	.6
50A14SS	61.80			2.809	.625	.6
50A15SS	68.20			3.006	.625	.7
50A16SS	74.60			3.204	.625	.8
50A17SS	75.20			3.401	.625	.8
50A18SS	81.50			3.599	.625	.9
50A19SS	88.00			3.797	.625	1.1
50A20SS	95.90			3.995	.625	1.2
50A21SS	103.00			4.193	.750	1.3
50A22SS	106.00	1	30.00	4.392	.750	1.5
50A23SS	111.00	2 - 4	21.00	4.590	.750	1.6
50A24SS	115.00	5 - 9	18.00	4.788	.750	1.8
		10 - 24	16.50			
50A25SS	121.00			4.987	.750	1.9
50A26SS	128.00			5.185	.750	2.0
50A28SS	140.00			5.582	.750	2.3
50A30SS	154.00			5.979	.750	2.7
50A32SS	167.00			6.376	.750	3.1
50A35SS	188.00			6.972	.750	3.7
50A36SS	196.00			7.171	.750	3.9
50A40SS	227.00			7.966	.750	4.9
50A45SS	269.00			8.960	1.000	6.2
50A48SS	302.00	1	40.00	9.556	1.000	7.0
50A54SS	365.00	2 - 4	28.00	10.749	1.000	8.8
50A60SS	424.00	5 - 9	24.00	11.942	1.000	10
		10 - 24	22.00			

DRILLING, COUNTERSINKING, SPOTFACING or TAPPING bolt holes - Add preparation charge of \$20.00 divided by the number of identical items plus \$2.50 per hole to list price for each operation required. (Use only one preparation charge when more than one operation is performed on the same part.)

SPLITTING - Add preparation charge of \$10.00 divided by the number of identical items plus \$.25 per tooth to the list price. This does not include reinforcing the rim or any other arrangement for holding the sprocket in pitch.



3/4" PITCH - SINGLE STRAND - STAINLESS STEEL

A.N.S.I. No. 60 - Type A Sprockets - No Hub - Mandrel Bore

Size and List Price		Alteration Charges - List Price Each		Dimensions - Weights		
Catalog No.	List Price	Quantity Identical	Re-Bore Each	Pitch Diameter	Stock Bore	Approx. Wt.
60A13SS	79.80			3.134	.750	1.0
60A14SS	86.30			3.370	.750	1.2
60A15SS	94.50			3.607	.750	1.3
60A16SS	103.00			3.844	.750	1.5
60A17SS	105.00			4.082	.750	1.7
60A18SS	112.00			4.319	.750	1.8
60A19SS	117.00			4.557	.750	2.0
60A20SS	118.00	1	30.00	4.794	.750	2.2
60A21SS	125.00	2 - 4	21.00	5.032	.750	2.5
60A22SS	134.00	5 - 9	18.00	5.270	1.000	2.8
60A23SS	141.00	10 - 24	16.50	5.508	1.000	3.1
60A24SS	149.00			5.746	1.000	3.3
60A25SS	156.00			5.984	1.000	3.6
60A26SS	164.00			6.222	1.000	3.9
60A28SS	182.00			6.699	1.000	4.6
60A30SS	198.00			7.175	1.000	5.3
60A32SS	218.00			7.652	1.000	5.9
60A35SS	249.00			8.367	1.000	7.2
60A36SS	261.00			8.605	1.000	7.6
60A40SS	304.00	1	40.00	9.559	1.000	9.4
60A45SS	364.00	2 - 4	28.00	10.752	1.000	11
60A60SS	590.00	5 - 9	24.00	14.330	1.250	20
		10 - 24	22.00			

DRILLING, COUNTERSINKING, SPOTFACING or TAPPING bolt holes - Add preparation charge of \$20.00 divided by the number of identical items plus \$3.00 per hole to list price for each operation required. (Use only one preparation charge when more than one operation is performed on the same part.)

SPLITTING - Add preparation charge of \$10.00 divided by the number of identical items plus \$.35 per tooth to the list price. This does not include reinforcing the rim or any other arrangement for holding the sprocket in pitch.

**80 A
Stainless**



1" PITCH - SINGLE STRAND - STAINLESS STEEL

A.N.S.I. No. 80 - Type A Sprockets - No Hub - Mandrel Bore

Size and List Price		Alteration Charges - List Price Each		Dimensions - Weights		
Catalog No.	List Price	Quantity Identical Items	Re-Bore Each	Pitch Diameter	Stock Bore	Approx. Wt.
80A12SS	149.00			3.864	1.000	1.9
80A13SS	163.00			4.179	1.000	2.2
80A14SS	176.00	1	30.00	4.494	1.000	2.6
		2 - 4	21.00			
80A15SS	190.00	5 - 9	18.00	4.810	1.000	3.0
80A16SS	204.00	10 - 24	16.50	5.126	1.000	3.3
80A17SS	220.00			5.442	1.000	3.7
80A18SS	235.00			5.759	1.000	4.2
80A19SS	254.00			6.076	1.000	4.7
80A20SS	270.00			6.392	1.000	5.1
80A21SS	288.00	1	40.00	6.710	1.000	5.7
80A22SS	307.00	2 - 4	28.00	7.027	1.000	6.2
		5 - 9	24.00			
80A23SS	325.00	10 - 24	22.00	7.344	1.000	6.8
80A24SS	344.00			7.661	1.000	7.4
80A25SS	365.00			7.979	1.000	8.0

DRILLING, COUNTERSINKING, SPOTFACING or TAPPING bolt holes - Add preparation charge of \$30.00 divided by the number of identical items plus \$4.00 per hole to list price for each operation required. (Use only one preparation charge when more than one operation is performed on the same part.)

SPLITTING - Add preparation charge of \$20.00 divided by the number of identical items plus \$.60 per tooth to the list price. This does not include reinforcing the rim or any other arrangement for holding the sprocket in pitch.



Special Tooth Profiles?

“Mud Relief” or other special configurations?

We can help.

800-547-2471

sales@linngear.com

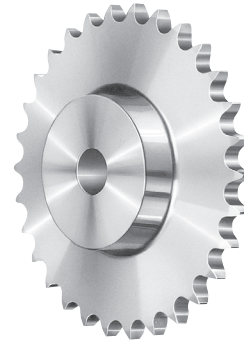
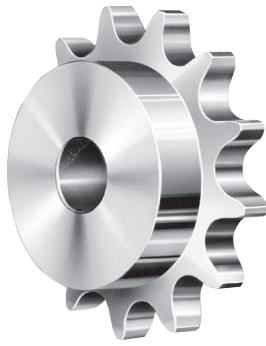

25 B
Stainless

1/4" PITCH - SINGLE STRAND - STAINLESS STEEL

A.N.S.I. No. 25 - Type B Sprockets - Hub One Side - Mandrel Bore

Size and List Price		Alteration Charges - List Price Each				Dimensions - Weights					
Catalog No.	List Price	Quantity Identical Items	Re-Bore Each	Each K.W.	Each S.S.	Pitch Diam.	Hub Diam.	Length Thru Bore	Stock Bore	Max. Bore	Approx. Weight
25B 9SS	34.20					.731	.59R	.625	.250	.250	.03
25B10SS	34.60					.809	.67R	.625	.250	.312	.03
25B11SS	36.40					.887	.75R	.625	.250	.375	.04
25B12SS	36.80					.966	.82R	.625	.250	.437	.06
25B13SS	37.20					1.045	.90R	.625	.250	.500	.07
25B14SS	39.40					1.124	.84	.625	.250	.500	.08
25B15SS	39.80					1.203	.92	.625	.250	.562	.1
25B16SS	40.20					1.282	1.01	.625	.250	.625	.1
25B17SS	43.20					1.361	1.09	.625	.250	.750	.1
25B18SS	43.80					1.440	1.17	.625	.250	.750	.2
25B19SS	44.60					1.519	1.25	.625	.250	.875	.2
25B20SS	46.80					1.598	1.32	.625	.250	.875	.2
25B21SS	49.60	1	30.00	12.00	12.00	1.678	1.40	.625	.250	1.000	.3
25B22SS	52.40	2 - 4	21.00	8.40	8.40	1.757	1.48	.625	.250	1.000	.3
25B23SS	55.20	5 - 9	18.00	7.20	7.20	1.836	1.56	.625	.250	1.062	.3
25B24SS	58.00	10 - 24	16.50	6.60	6.60	1.915	1.62	.625	.375	1.125	.3
25B25SS	60.80					1.995	1.62	.625	.375	1.125	.3
25B26SS	64.70					2.074	1.62	.625	.375	1.125	.3
25B28SS	72.40					2.233	1.62	.625	.375	1.125	.4
25B30SS	79.90					2.392	1.75	.625	.375	1.250	.4
25B32SS	86.00					2.551	1.75	.625	.375	1.250	.4
25B35SS	94.40					2.789	1.75	.750	.375	1.250	.5
25B36SS	102.00					2.869	1.75	.750	.375	1.250	.5
25B40SS	124.00					3.187	2.00	.750	.500	1.375	.5
25B45SS	150.00					3.584	2.00	.750	.500	1.375	.6
25B60SS	205.00					4.777	2.00	.750	.500	1.375	1.1

Hub Diameters marked "R" are recessed for chain clearance.

Listed maximum bore is with setscrew at angle to keyway. Larger bores are subject to additional charge.

Stock sprockets are Type 303 or 304 Stainless. Sprockets made from other grades of Stainless Steel or from Bronze can readily be supplied. Inquire for prices.

LINN GEAR COMPANY

**35 B
Stainless**

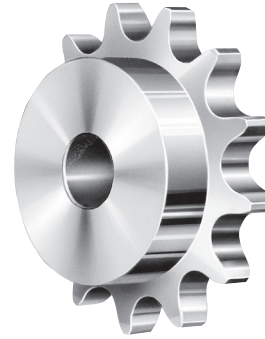
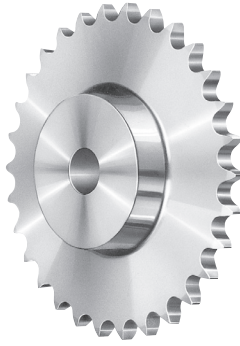

3/8" PITCH - SINGLE STRAND - STAINLESS STEEL

A.N.S.I. No. 35 - Type B Sprockets - Hub One Side - Mandrel Bore

Size and List Price		Alteration Charges - List Price Each				Dimensions - Weights					
Catalog No.	List Price	Quantity Identical Items	Re-Bore Each	Each K.W.	Each S.S.	Pitch Diam.	Hub Diam.	Length Thru Bore	Stock Bore	Max. Bore	Approx. Weight
35B 9SS	39.40					1.096	.87R	.750	.375	.375	.2
35B10SS	40.20					1.214	1.00R	.750	.375	.500	.2
35B11SS	43.40					1.331	1.10R	.750	.375	.625	.2
35B12SS	44.00					1.449	1.23R	.750	.500	.750	.3
35B13SS	47.40					1.567	1.34R	.750	.500	.875	.3
35B14SS	48.00					1.685	1.25	.750	.500	.875	.3
35B15SS	52.60					1.804	1.37	.750	.500	.875	.4
35B16SS	53.20					1.922	1.50	.750	.500	1.000	.4
35B17SS	56.00					2.041	1.62	.750	.500	1.125	.5
35B18SS	57.20					2.159	1.73	.750	.500	1.187	.5
35B19SS	58.00					2.278	1.85	.750	.500	1.312	.7
35B20SS	65.00					2.397	1.98	.875	.500	1.375	.8
35B21SS	71.20	1	30.00	12.00	12.00	2.516	2.09	.875	.500	1.375	.9
35B22SS	77.40	2 - 4	21.00	8.40	8.40	2.635	2.21	.875	.500	1.500	1.0
35B23SS	83.60	5 - 9	18.00	7.20	7.20	2.754	2.34	.875	.500	1.500	1.1
35B24SS	89.80	10 - 24	16.50	6.60	6.60	2.873	2.45	.875	.500	1.500	1.1
35B25SS	96.00					2.992	2.57	.875	.500	1.500	1.1
35B26SS	102.00					3.111	2.70	.875	.500	1.500	1.2
35B28SS	114.00					3.349	2.93	.875	.500	1.500	1.2
35B30SS	126.00					3.588	3.00	.875	.500	1.500	1.3
35B32SS	140.00					3.826	3.00	.875	.500	1.500	1.4
35B35SS	153.00					4.183	3.00	.875	.500	1.750	1.6
35B36SS	162.00					4.303	3.00	.875	.500	1.750	1.7
35B40SS	180.00					4.780	3.00	1.000	.500	1.750	1.8
35B45SS	200.00					5.376	3.00	1.000	.500	1.750	2.1
35B60SS	282.00					7.165	2.50	1.000	.625	1.750	2.9

Hub Diameters marked "R" are recessed for chain clearance.

Listed maximum bore is with setscrew at angle to keyway. Larger bores are subject to additional charge.

Stock sprockets are Type 303 or 304 Stainless. Sprockets made from other grades of Stainless Steel or from Bronze can readily be supplied. Inquire for prices.



41 B
Stainless

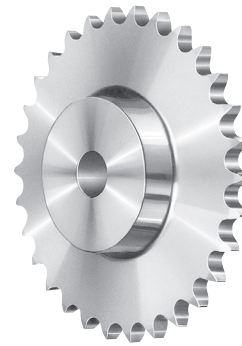
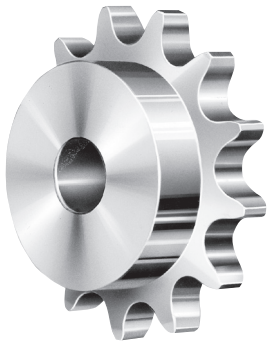

1/2" PITCH (.306" ROLL) - SINGLE STRAND - STAINLESS STEEL

A.N.S.I. No. 41 - Type B Sprockets - Hub One Side - Mandrel Bore

Size and List Price		Alteration Charges - List Price Each				Dimensions - Weights					
Catalog No.	List Price	Quantity Identical Items	Re-Bore Each	Each K.W.	Each S.S.	Pitch Diam.	Hub Diam.	Length Thru Bore	Stock Bore	Max. Bore	Approx. Weight
41B 9SS	44.80					1.462	1.14R	.875	.500	.625	.2
41B10SS	48.40					1.618	1.29R	.875	.500	.812	.2
41B11SS	54.40					1.775	1.45R	.875	.500	.875	.2
41B12SS	55.20					1.932	1.60R	.875	.500	1.062	.3
41B13SS	60.80	1	30.00	12.00	12.00	2.089	1.76R	.875	.500	1.187	.5
41B14SS	61.60	2 - 4	21.00	8.40	8.40	2.247	1.75	.875	.500	1.250	.6
41B15SS	68.60	5 - 9	18.00	7.20	7.20	2.405	1.92	.875	.500	1.312	.7
41B16SS	70.80	10 - 24	16.50	6.60	6.60	2.563	2.07	.875	.500	1.375	.8
41B17SS	75.60					2.721	2.23	.875	.625	1.500	.9
41B18SS	82.00					2.879	2.40	.875	.625	1.687	1.0
41B19SS	91.80					3.038	2.56	.875	.625	1.750	1.2
41B20SS	104.00					3.196	2.71	1.000	.625	1.750	1.3

Hub Diameters marked "R" are recessed for chain clearance.

Listed maximum bore is with setscrew at angle to keyway. Larger bores are subject to additional charge.

Broken gear or sprocket? We can help. 800-547-2471 or sales@linngear.com

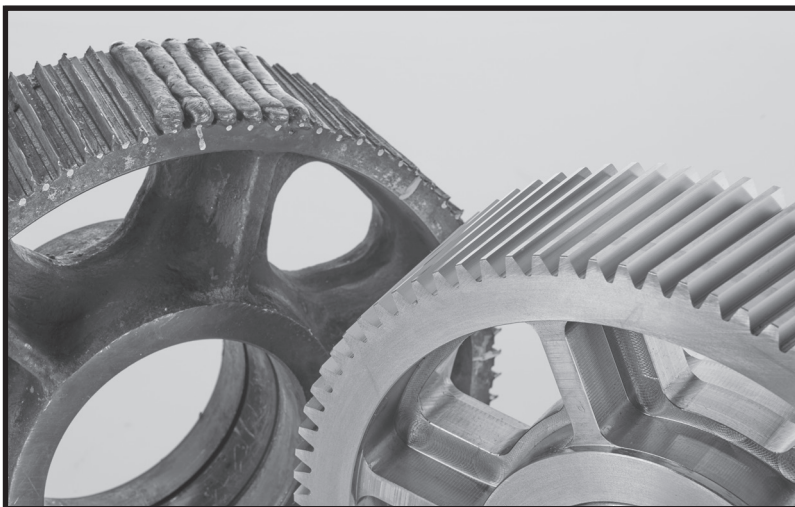

LINN GEAR COMPANY

**40 B
Stainless**

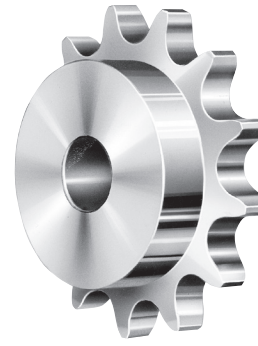
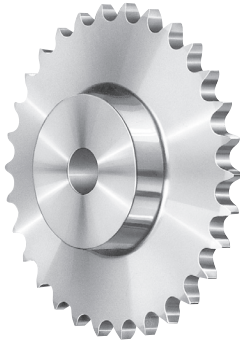

1/2" PITCH (.312" ROLL) - SINGLE STRAND - STAINLESS STEEL

A.N.S.I. No. 40 - Type B Sprockets - Hub One Side - Mandrel Bore

Size and List Price		Alteration Charges - List Price Each				Dimensions - Weights					
Catalog No.	List Price	Quantity Identical Items	Re-Bore Each	Each K.W.	Each S.S.	Pitch Diam.	Hub Diam.	Length Thru Bore	Stock Bore	Max. Bore	Approx. Weight
40B 8SS	41.80					1.307	.98R	.875	.500	.500	.2
40B 9SS	44.80					1.462	1.14R	.875	.500	.625	.2
40B10SS	48.40					1.618	1.29R	.875	.500	.815	.2
40B11SS	54.40					1.775	1.45R	.875	.500	.875	.3
40B12SS	55.20					1.932	1.60R	.875	.500	1.062	.4
40B13SS	60.80					2.089	1.76R	.875	.500	1.187	.5
40B14SS	64.90					2.247	1.68	.875	.500	1.250	.6
40B15SS	68.40					2.405	1.85	.875	.500	1.312	.7
40B16SS	72.90					2.563	2.01	.875	.500	1.375	.8
40B17SS	75.60					2.721	2.17	.875	.625	1.500	.9
40B18SS	82.00					2.879	2.34	.875	.625	1.687	1.0
40B19SS	91.80					3.038	2.50	.875	.625	1.750	1.2
40B20SS	104.00	1	30.00	12.00	12.00	3.196	2.65	1.000	.625	1.750	1.4
40B21SS	114.00	2 - 4	21.00	8.40	8.40	3.355	2.81	1.000	.625	1.750	1.9
40B22SS	125.00	5 - 9	18.00	7.20	7.20	3.513	2.98	1.000	.625	1.750	2.0
40B23SS	135.00	10 - 24	16.50	6.60	6.60	3.672	3.14	1.000	.625	2.000	2.1
40B24SS	146.00					3.831	3.29	1.000	.625	2.000	2.1
40B25SS	154.00					3.989	3.00	1.000	.625	2.000	2.2
40B26SS	165.00					4.148	3.00	1.000	.625	2.000	2.3
40B28SS	186.00					4.466	3.00	1.000	.625	2.000	2.5
40B30SS	206.00					4.783	3.00	1.000	.625	2.000	2.6
40B32SS	216.00					5.101	3.00	1.000	.625	2.000	2.8
40B35SS	228.00					5.578	3.00	1.000	.625	2.000	3.2
40B36SS	240.00					5.737	3.00	1.000	.625	2.000	3.3
40B40SS	272.00					6.373	3.00	1.000	.750	1.750	3.8
40B45SS	290.00					7.168	2.75	1.000	.750	1.750	4.5
40B48SS	302.00					7.645	2.75	1.000	.750	1.750	4.9
40B54SS	335.00					8.599	2.75	1.000	.750	1.750	5.9
40B60SS	365.00					9.554	2.75	1.000	.750	1.750	7

Hub Diameters marked "R" are recessed for chain clearance.

Listed maximum bore is with setscrew at angle to keyway. Larger bores are subject to additional charge.

Stock sprockets are Type 303 or 304 Stainless. Sprockets made from other grades of Stainless Steel or from Bronze can readily be supplied. Inquire for prices.

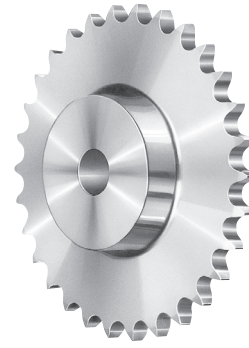
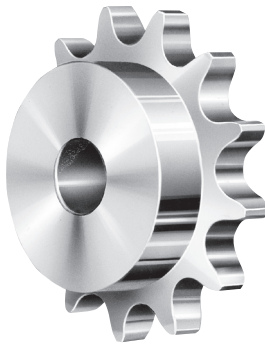

5/8" PITCH - SINGLE STRAND - STAINLESS STEEL

A.N.S.I. No. 50 - Type B Sprockets - Hub One Side - Mandrel Bore

Size and List Price		Alteration Charges - List Price Each				Dimensions - Weights					
Catalog No.	List Price	Quantity Identical Items	Re-Bore Each	Each K.W.	Each S.S.	Pitch Diam.	Hub Diam.	Length Thru Bore	Stock Bore	Max. Bore	Approx. Weight
50B 8SS	52.40					1.633	1.20R	1.000	.625	.625	.2
50B 9SS	59.40					1.827	1.40R	1.000	.625	.812	.3
50B10SS	66.80					2.023	1.60R	1.000	.625	.937	.5
50B11SS	78.40					2.219	1.81R	1.000	.625	1.187	.6
50B12SS	79.40	1	30.00	12.00	12.00	2.415	2.00R	1.000	.625	1.250	.7
50B13SS	82.60	2 - 4	21.00	8.40	8.40	2.612	1.93	1.000	.625	1.312	.8
50B14SS	91.20	5 - 9	18.00	7.20	7.20	2.809	2.14	1.000	.625	1.375	1.0
50B15SS	96.40	10 - 24	16.50	6.60	6.60	3.006	2.34	1.000	.625	1.562	1.2
50B16SS	105.00					3.204	2.53	1.000	.625	1.750	1.4
50B17SS	110.00					3.401	2.73	1.000	.625	1.750	1.7
50B18SS	120.00					3.599	2.93	1.000	.625	1.937	2.0
50B19SS	131.00					3.797	3.12	1.000	.625	2.125	2.2
50B20SS	148.00					3.995	3.32	1.000	.625	2.250	2.4
50B21SS	170.00					4.193	3.25	1.000	.625	2.250	2.8
50B22SS	192.00					4.392	3.25	1.000	.625	2.250	2.9
50B23SS	214.00					4.590	3.50	1.000	.625	2.250	3.0
50B24SS	237.00					4.788	3.50	1.000	.625	2.250	3.2
50B25SS	256.00					4.987	3.50	1.000	.750	2.250	3.4
50B26SS	270.00	1	40.00	16.00	16.00	5.185	3.50	1.000	.750	2.250	3.5
50B28SS	284.00	2 - 4	28.00	11.20	11.20	5.582	3.50	1.000	.750	2.250	3.8
		5 - 9	24.00	9.60	9.60						
50B30SS	302.00	10 - 24	22.00	8.80	8.80	5.979	3.50	1.250	.750	2.250	4.8
50B32SS	318.00					6.376	3.50	1.250	.750	2.250	5.1
50B35SS	328.00					6.972	3.25	1.250	.750	2.250	5.8
50B36SS	348.00					7.171	3.25	1.250	.750	2.250	5.9
50B40SS	370.00					7.966	3.25	1.250	.750	2.250	6.9
50B45SS	409.00					8.960	3.25	1.250	1.000	2.250	8.2
50B48SS	445.00					9.556	3.25	1.250	1.000	2.250	8.7
50B54SS	510.00					10.749	3.25	1.250	1.000	2.250	10
50B60SS	570.00					11.942	3.25	1.250	1.000	2.250	13

Hub Diameters marked "R" are recessed for chain clearance.

Listed maximum bore is with setscrew at angle to keyway. Larger bores are subject to additional charge.

Stock sprockets are Type 303 or 304 Stainless. Sprockets made from other grades of Stainless Steel or from Bronze can readily be supplied. Inquire for prices.

LINN GEAR COMPANY

**60 B
Stainless**

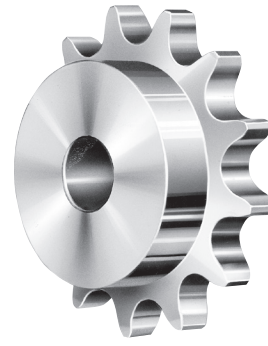
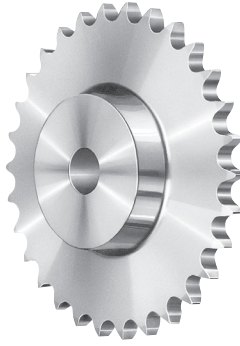

3/4" PITCH - SINGLE STRAND - STAINLESS STEEL

A.N.S.I. No. 60 - Type B Sprockets - Hub One Side - Mandrel Bore

Size and List Price		Alteration Charges - List Price Each				Dimensions - Weights					
Catalog No.	List Price	Quantity Identical Items	Re-Bore Each	Each K.W.	Each S.S.	Pitch Diam.	Hub Diam.	Length Thru Bore	Stock Bore	Max. Bore	Approx. Weight
60B 8SS	68.20					1.960	1.46R	1.250	.625	.750	.5
60B 9SS	75.20					2.193	1.70R	1.250	.750	1.000	.6
60B10SS	83.00					2.427	1.93R	1.250	.750	1.187	.7
60B11SS	93.40					2.662	2.17R	1.250	.750	1.375	.9
60B12SS	99.00					2.898	2.40R	1.250	.750	1.500	1.3
60B13SS	109.00					3.134	2.31	1.250	.750	1.562	1.8
60B14SS	118.00					3.371	2.56	1.250	.750	1.750	2.0
60B15SS	142.00					3.607	2.79	1.250	.750	1.750	2.4
60B16SS	155.00	1	40.00	16.00	16.00	3.844	3.03	1.250	.750	2.000	2.8
60B17SS	171.00	2 - 4	28.00	11.20	11.20	4.082	3.28	1.250	.750	2.250	3.3
60B18SS	186.00	5 - 9	24.00	9.60	9.60	4.319	3.53	1.250	.750	2.250	3.8
60B19SS	202.00	10 - 24	22.00	8.80	8.80	4.557	3.76	1.250	.750	2.500	4.3
60B20SS	220.00					4.794	3.95	1.250	.750	2.750	4.5
60B21SS	242.00					5.032	4.00	1.250	.750	2.750	5.3
60B22SS	261.00					5.270	4.00	1.250	.750	2.750	5.6
60B23SS	281.00					5.508	4.00	1.250	.750	2.750	5.8
60B24SS	306.00					5.746	4.00	1.250	.750	2.750	6.1
60B25SS	332.00					5.984	4.00	1.250	1.000	2.750	6.3
60B26SS	345.00					6.222	3.50	1.250	1.000	2.250	6.4
60B28SS	370.00					6.699	3.50	1.250	1.000	2.250	6.6
60B30SS	390.00					7.175	3.50	1.250	1.000	2.250	7.3
60B32SS	410.00					7.652	3.50	1.250	1.000	2.250	8.0
60B35SS	440.00					8.367	3.75	1.250	1.000	2.500	9.5
60B36SS	450.00	1	50.00	20.00	20.00	8.605	3.75	1.250	1.000	2.500	9.9
60B40SS	505.00	2 - 4	35.00	14.00	14.00	9.559	3.75	1.250	1.000	2.500	12
60B45SS	590.00	5 - 9	30.00	12.00	12.00	10.752	3.75	1.250	1.000	2.500	14
60B60SS	820.00	10 - 24	28.00	11.00	11.00	14.330	3.75	1.500	1.250	2.500	23

Hub Diameters marked "R" are recessed for chain clearance.

Listed maximum bore is with setscrew at angle to keyway. Larger bores are subject to additional charge.

Stock sprockets are Type 303 or 304 Stainless. Sprockets made from other grades of Stainless Steel or from Bronze can readily be supplied. Inquire for prices.

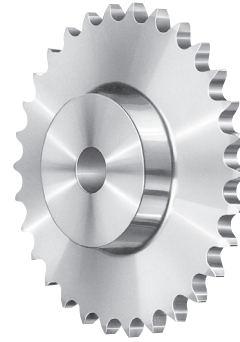
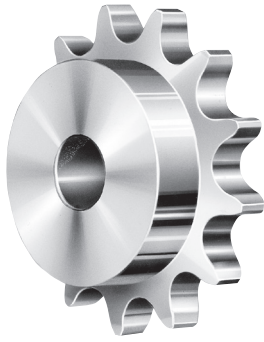

**80 B
Stainless**

1" PITCH - SINGLE STRAND - STAINLESS STEEL

A.N.S.I. No. 80 - Type B Sprockets - Hub One Side - Mandrel Bore

Size and List Price		Alteration Charges - List Price Each				Dimensions - Weights					
Catalog No.	List Price	Quantity Identical Items	Re-Bore Each	Each K.W.	Each S.S.	Pitch Diam.	Hub Diam.	Length Thru Bore	Stock Bore	Max. Bore	Approx. Weight
80B10SS	150.00					3.236	2.59R	1.500	1.000	1.562	2.0
80B11SS	180.00	1	40.00	16.00	16.00	3.549	2.90R	1.500	1.000	1.812	2.6
80B12SS	200.00	2 - 4	28.00	11.20	11.20	3.864	2.78	1.500	1.000	1.812	3.0
		5 - 9	24.00	9.60	9.60						
80B13SS	220.00	10 - 24	22.00	8.80	8.80	4.179	3.10	1.500	1.000	2.125	3.6
80B14SS	260.00					4.494	3.43	1.500	1.000	2.250	4.4
80B15SS	304.00					4.810	3.78	1.500	1.000	2.500	5.2
80B16SS	325.00					5.126	4.09	1.500	1.000	2.750	6.2
80B17SS	366.00					5.442	4.00	1.500	1.000	2.750	6.9
80B18SS	414.00					5.759	4.00	1.500	1.000	2.750	7.4
		1	50.00	20.00	20.00						
80B19SS	435.00	2 - 4	35.00	14.00	14.00	6.076	4.00	1.500	1.000	2.750	7.9
80B20SS	485.00	5 - 9	30.00	12.00	12.00	6.392	4.00	1.500	1.000	2.750	8.3
80B21SS	515.00	10 - 24	28.00	11.00	11.00	6.710	4.00	1.500	1.000	2.750	9.2
80B22SS	535.00					7.027	4.00	1.500	1.000	2.750	9.7
80B23SS	555.00					7.344	4.00	1.500	1.000	2.750	10
80B24SS	575.00					7.661	4.00	1.500	1.000	2.750	11
80B25SS	600.00					7.979	4.00	1.500	1.000	2.750	12

Hub Diameters marked "R" are recessed for chain clearance.

Listed maximum bore is with setscrew at angle to keyway. Larger bores are subject to additional charge.

Stock sprockets are Type 303 or 304 Stainless. Sprockets made from other grades of Stainless Steel or from Bronze can readily be supplied. Inquire for prices.

**METRIC STAINLESS STEEL
Sprockets & Gears Available Made-To-Order**

LINN GEAR COMPANY

**100 B
Stainless**

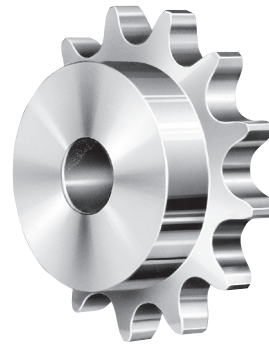
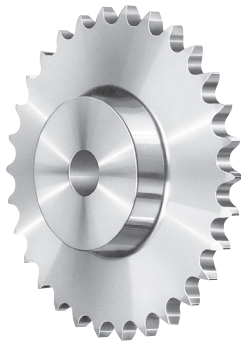

1 1/4" PITCH - SINGLE STRAND - STAINLESS STEEL

A.N.S.I. No. 100 - Type B Sprockets - Hub One Side - Mandrel Bore

Size and List Price		Alteration Charges - List Price Each				Dimensions - Weights					
Catalog No.	List Price	Quantity Identical Items	Re-Bore Each	Each K.W.	Each S.S.	Pitch Diam.	Hub Diam.	Length Thru Bore	Stock Bore	Max. Bore	Approx. Weight
100B11SS	313.00	1	40.00	16.00	16.00	4.437	3.07	1.750	1.000	2.000	4.5
100B12SS	363.00	2 - 4	28.00	11.20	11.20	4.830	3.48	1.750	1.250	2.250	5.5
100B13SS	414.00	5 - 9	24.00	9.60	9.60	5.223	3.89	1.750	1.250	2.625	6.8
		10 - 24	22.00	8.80	8.80						
100B14SS	470.00					5.617	4.29	1.750	1.250	2.750	8.2
100B15SS	535.00	1	50.00	20.00	20.00	6.012	4.25	1.750	1.250	2.750	9.0
100B16SS	600.00	2 - 4	35.00	14.00	14.00	6.407	4.25	1.750	1.250	2.750	10
		5 - 9	30.00	12.00	12.00						
100B17SS	660.00	10 - 24	28.00	11.00	11.00	6.803	4.25	1.750	1.250	2.750	11
100B18SS	720.00					7.198	4.25	1.750	1.250	2.750	12

Listed maximum bore is with setscrew at angle to keyway. Larger bores are subject to additional charge.

Stock sprockets are Type 303 or 304 Stainless. Sprockets made from other grades of Stainless Steel or from Bronze can readily be supplied. Inquire for prices.

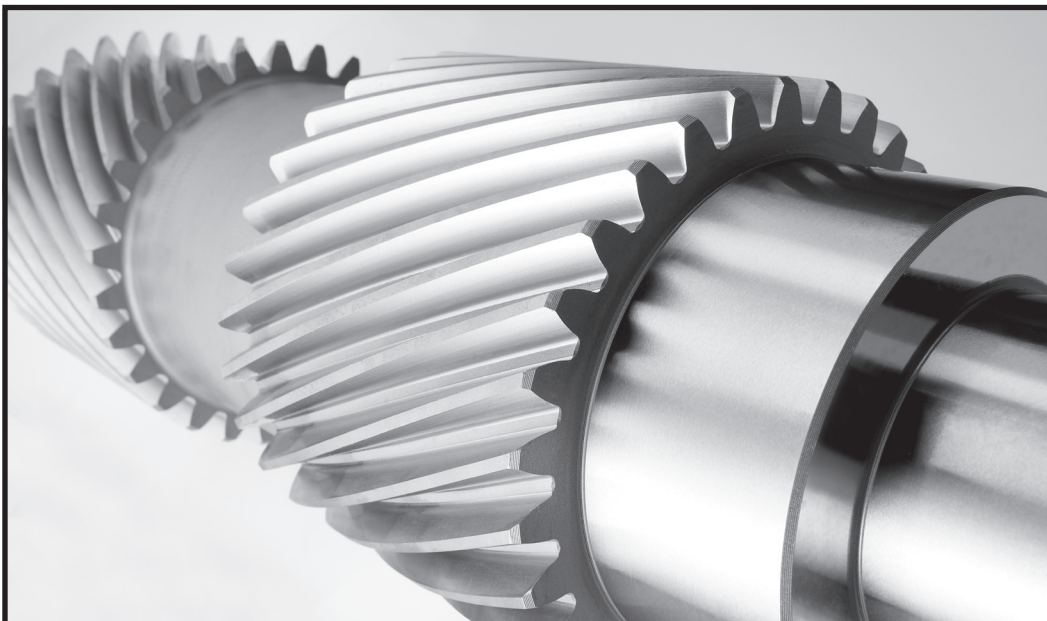

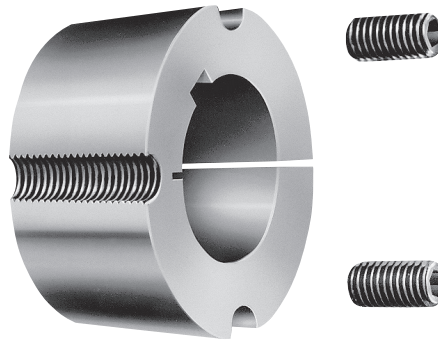

Taper - Lock®
Bushings

Steel and Stainless Steel TAPER - LOCK® Bushings

Size and List Price					Alteration Charges			Dimensions - Weights		
Steel		Stainless Steel		Plain No.	Quantity Price	Re-Bore Stock Bore	Each Identical Items	Max. Each	Length Kwy	Bore
Bushing Appx. Wt.	List	Bushing No.	List Price							
1610S	29.60	1610SS	88.80	.500	1	60.00	24.00	1.625	1.00	.7
1615S	30.80	1615SS	92.40	.500	2 - 4	42.00	16.80	1.625	1.50	.8
2012S	40.00	2012SS	120.00	.500	5 - 9	36.00	14.40	2.000	1.25	1.2
2517S	49.20	2517SS	148.00	.500	10 - 24	33.00	13.20	2.500	1.75	2.4
2525S	88.00	3020SS	222.00	.750	1	70.00	28.00	2.500	2.50	3.3
3020S	111.00			.750	2 - 4	49.00	19.60	3.000	2.00	4.5
3030S	162.00			.750	5 - 9	42.00	16.80	3.000	3.00	6
					10 - 24	39.00	15.40			
3535S	230.00			1.000	1	100.00	40.00			
4040S	370.00			1.000	2 - 4	70.00	28.00	3.500	3.50	9
4545S	460.00			1.000	5 - 9	60.00	24.00	4.000	4.00	16
					10 - 24	55.00	22.00	4.500	4.50	20

Other sizes or materials are available made-to-order. Please inquire for a quotation.

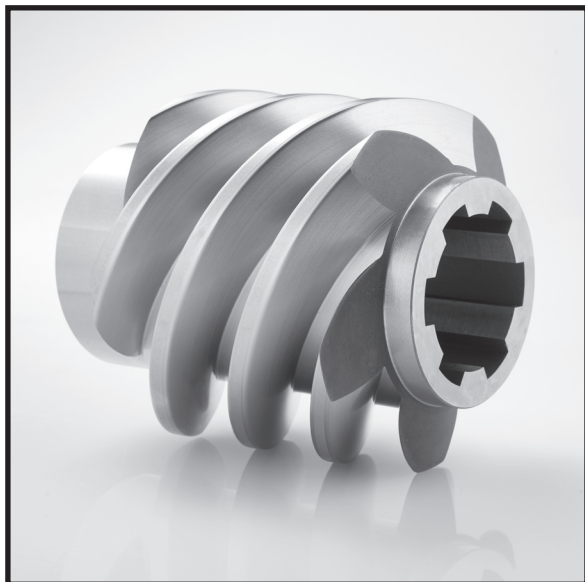

Ask us about

HIGH PRECISION GEARING

Work Envelope: 49" dia. x 59" height

Spur, Helical, Double Helical & Worm

Internal & External

Profile Modification

Reverse Engineering

Gearbox Rebuild

To AGMA Q14 or better

Certified Inspection



See next page for additional details.